

카스토퍼 518

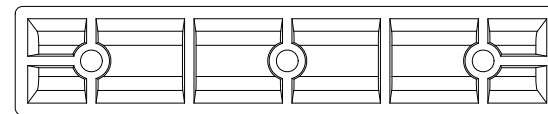
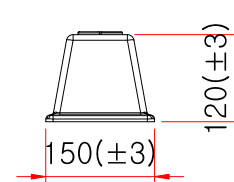
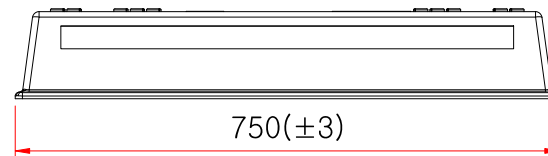
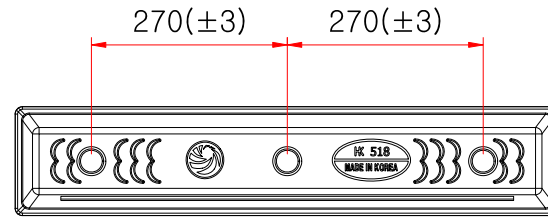
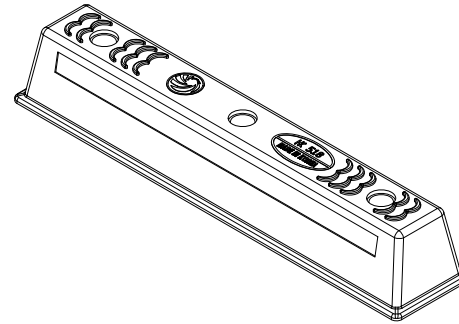

SIDE ELEVATION
SCALE : NONE

- * 치수는 사정에 따라 변경됩니다
- * 자세한 제품 문의는 031-592-4161

품명	카스토퍼 518		
규격	L750mm * W150mm * H120mm		
척도	1 : 1	제도	JUNG.h u
재료	합성원료	날짜	2023.04.01



(주)해광